

Customer Name:			
Customer Part Number:			
Approved By:		Date:	

Prepared By	Checked By	Approved By

Table of Contents

Revision History.....	3
1 General Specifications.....	4
2 Pin Assignment.....	5
3 Absolute Maximum Ratings.....	6
4 Electrical Characteristics.....	6
5 INTERFACE TIMING.....	8
5.1 System Bus Read/Write Characteristics.....	8
5.2 Power ON/OFF Timing.....	9
6 Optical Characteristics.....	10
7 Environmental / Reliability Test.....	14
8 Mechanical Drawing.....	15
9 Precautions For Use of LCD Modules.....	16

Revision History

Rev	Issued Date	Description	Page	Editor
1.0	Jun 18.2019	First release	All	

1 General Specifications

	Feature	Specifications
Display Spec.	LCD type	2.1 inch
	Resolution (H*V)	480(RGB)×480
	Technology Type	a-Si TFT
	Pixel Configuration	R.G.B. Vertical Stripe
	Display Mode	Normally Black
	Viewing Direction	ALL
	Gray Scale Inversion Direction	-
Mechanical Characteristics	OutlineDimensions (W x H x T) (mm)	56.18*59.71*2.3
	Active Area(mm)	53.28*53.28
	CTP View Area(mm)	/
	With /Without Touch screen	Without
	Connector Type	0.5 PITCH 40PIN
	Backlight Type	LED
	Weight (g)	TBD
Electrical Characteristics	Display Interface	3SPI+18RGB
	Number of color	262K
	Display Driver IC	ST7701S
	Touch Driver IC	/

Note 1: Viewing direction for best image quality is different from TFT definition. There is a 180 degree shift.

2 Pin Assignment

1	LED A	LED ANODE
2	LED K	LED CATHODE
3	LED K	LED CATHODE
4	GND	Ground
5	VCI	Power supply
6	RESET	Reset Signal ,Active Low
7	NC	NC
8	NC	NC
9	SDA	SPI Data signal
10	SCK	SPI Clock signal
11	CS	SPI Chip select signal
12	PCLK	RGB dot clock signal
13	DE	RGB data enable signal
14	VSYNC	RGB frame synchronizing signal
15	HSYNC	RGB line synchronizing signal
16~33	DB0~DB17	RGB data signal (DB0:BLUE LSB;DB5:BIUE MSB;DB6:GREEN LSB;DB11:GREEN, MSB;DB12:RED LSB;DB17:RED MSB)
34	GND	Ground
35	TP_INT	Touch Interrupt
36	TP_SDA	Touch IIC Data signal
37	TP_SCL	Touch IIC Clock signal
38	TP_RESET	Touch Reset Signal
39	TP_VCI	Touch Power supply
40	GND	Ground

Note:

1:3SPI+18RGB interface

Item	Symbol	Value	Unit
Power supply voltage for logic	V_{DD}	0.3~4.8	V
Input voltage	V_{in}	$V_{DD}+0.3$	V
Operating temperature	T_{opr}	-20 to 70	°C
Storage temperature	T_{stg}	-30 to 80	°C

Note: Note1: Absolute maximum rating is the limit value beyond which the IC maybe broken.

They do not assure operations.

Note2: Background color changes slightly depending on ambient temperature. This Phenomenon is reversible.

$T_a \leq 70^\circ\text{C}$: 75%RH max

$T_a > 70^\circ\text{C}$: absolute humidity must be lower than the humidity of 75%RH at 70°C

Note3: T_a at -30°C will be <48hrs, at 80°C will be <120hrs

4 Electrical Characteristics

4.1 Driving TFT LCD Panel

Item	Symbol	Min	Type	Max	Unit	Test condition
Operating voltage	V_{DD}	2.5	2.8	4.8	V	-
Supply current	I_{DD}	-	-	50	mA	$V_{DD}=2.8\text{V}, T_a=25^\circ\text{C}$
Input voltage	V_{IH}	0.8VDD	-	VDD	V	-
	V_{IL}	0	-	0.2VDD	V	
Input leakage current	I_{IL}	-1.0	-	1.0	μA	$V_{IN}=V_{DD}$ or V_{SS}

Note: Voltage greater than above may damage the module.

All voltages are specified relative to $V_{SS}=0\text{V}$.

4.2 Driving Backlight

$T_a=25^\circ\text{C}$

Item	Symbol	Min	Typ	Max	Unit	Remark
Forward Current	I_F	--	80	88	mA	
Forward Voltage	V_F	-	3.2	-	V	
Connection mode		--	4Parallel	--		
LED number	/		4		pcs	

Note1: Optical performance should be evaluated at $T_a=25^\circ\text{C}$ only .If LED is driven by high current, high ambient temperature & humidity condition. The life time of LED will be reduced. Operating life means brightness goes down to 50% initial brightness. Typical operating life time is estimated data.

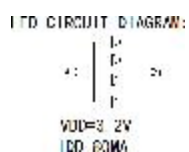

4.3 Block Diagram

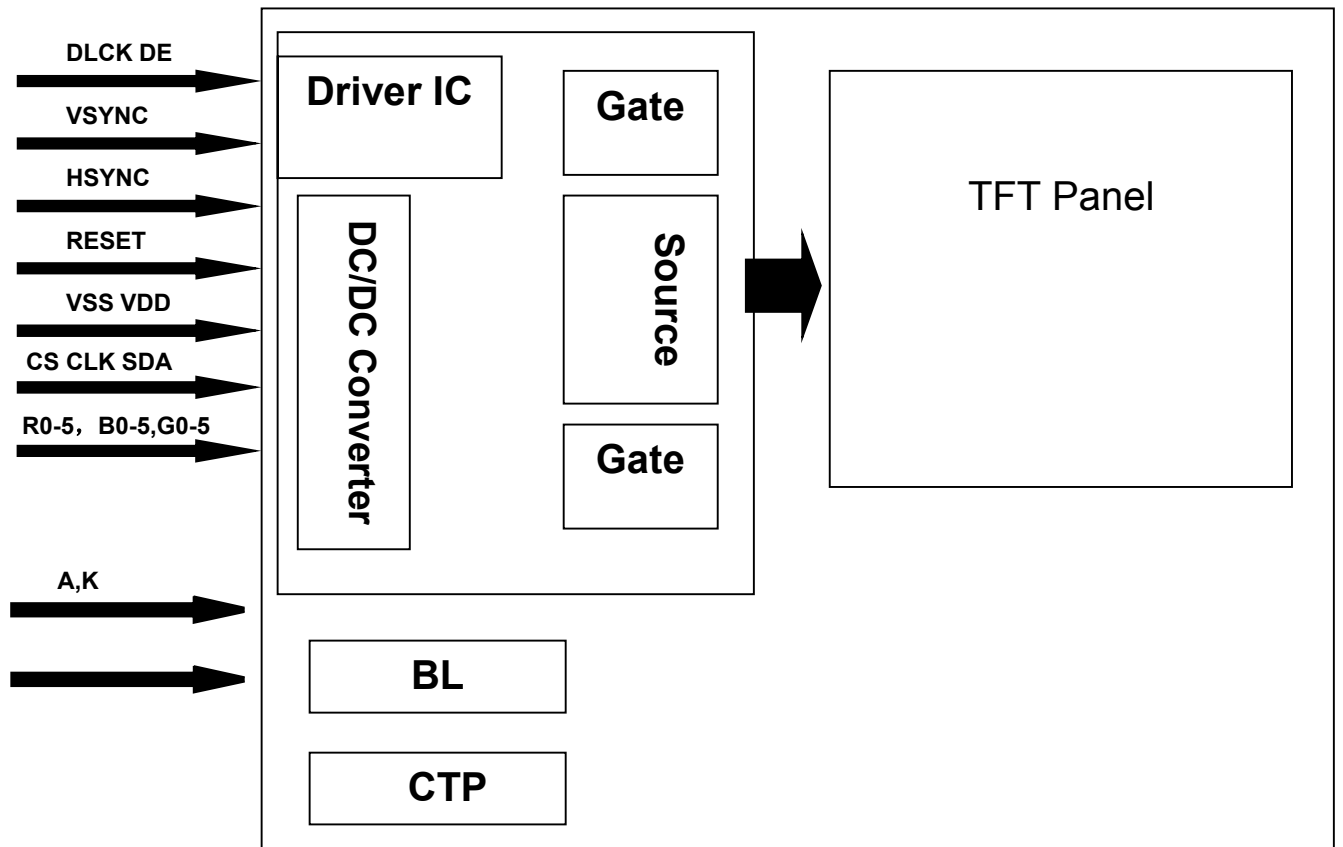

5 INTERFACE TIMING

5.1 System Bus Read/Write Characteristics.

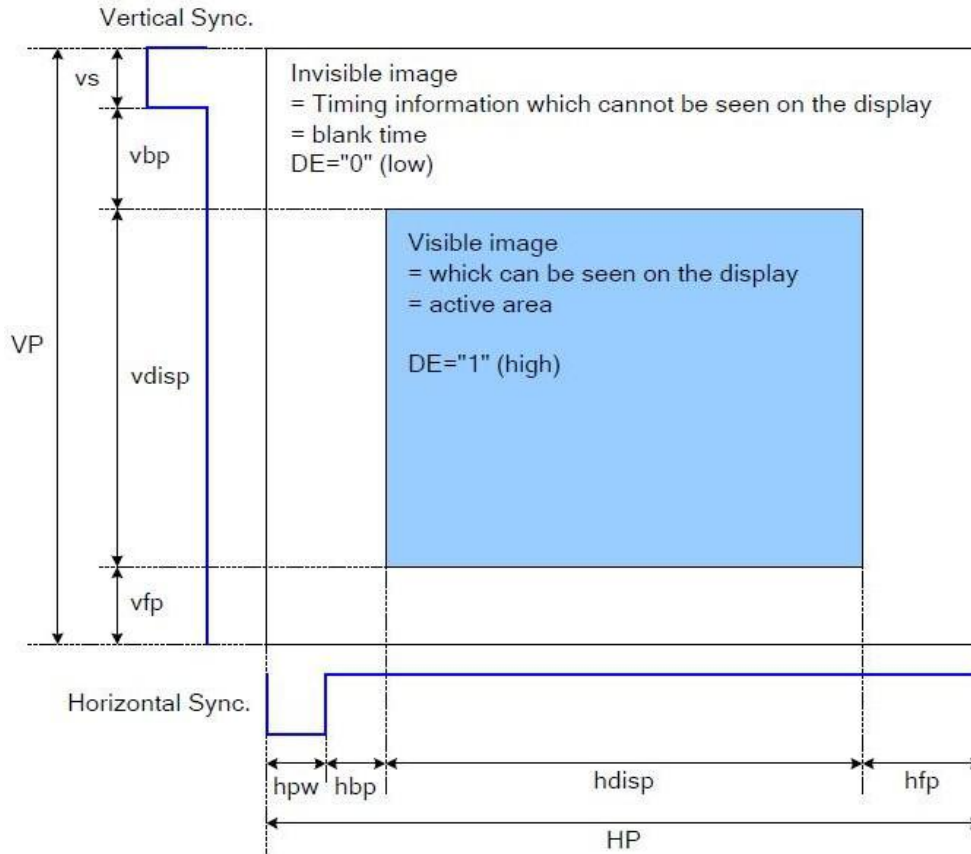

Please refer to the following table for the setting limitation of RGB interface signals.

Parameter	Symbol	Min.	Typ.	Max.	Unit
Horizontal Sync. Width	hwp	1	-	255	Clock
Horizontal Sync. Back Porch	hbp	1	--	255	Clock
Horizontal Sync. Front Porch	hfp	1	--	-	Clock
Vertical Sync. Width	vs	1	--	254	Line
Vertical Sync. Back Porch	vbp	1	--	254	Line
Vertical Sync. Front Porch	vfp	2	--	--	Line

Note:

1. Typical value are related to the setting frame rate is 60Hz.

5.2 Power ON/OFF Timing

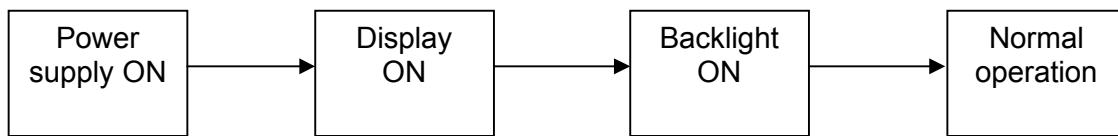
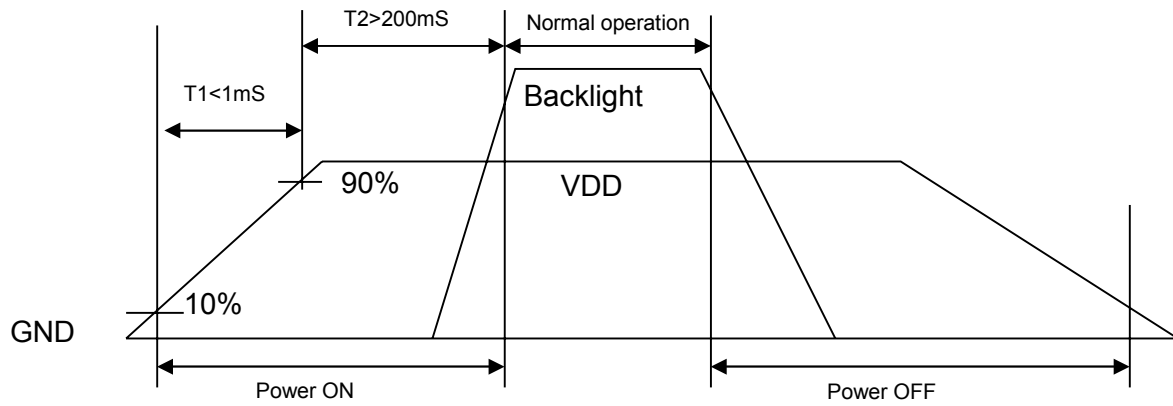

Power ON sequence

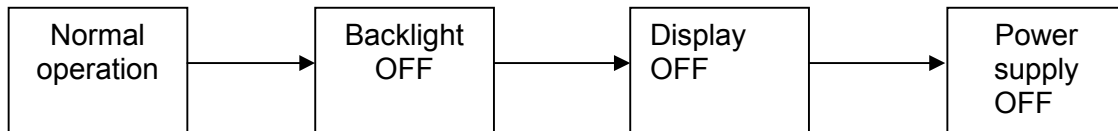

Power OFF sequence

Ta=25°C

Item	Symbol	Condition	Min	Typ	Max	Unit	Remark
View Angles	θ_T	$CR \geq 10$	-	80	-	Degree	Note 2
	θ_B		-	80	-		
	θ_L		-	80	-		
	θ_R		-	80	-		
Contrast Ratio	CR	$\theta=0^\circ$	700	900	-	-	Note1 Note3
Response Time	T_{ON}	25°C	-	30	40	ms	Note1
	T_{OFF}						Note4
Uniformity	U	-	70	80	-	%	Note1 Note6
NTSC	-	-	-	70	-	%	Note 5
Luminance	L		280	300	-	cd/m ²	Note1 Note7

Test Conditions:

1. $V_F=3.2V$, $I_F=80mA$, the ambient temperature is 25°C.
2. The test systems refer to Note 1 and Note 2.

Note 1: Definition of optical measurement system.

The optical characteristics should be measured in dark room. After 5 minutes operation, the optical properties are measured at the center point of the LCD screen. All input terminals LCD panel must be ground when measuring the center area of the panel.

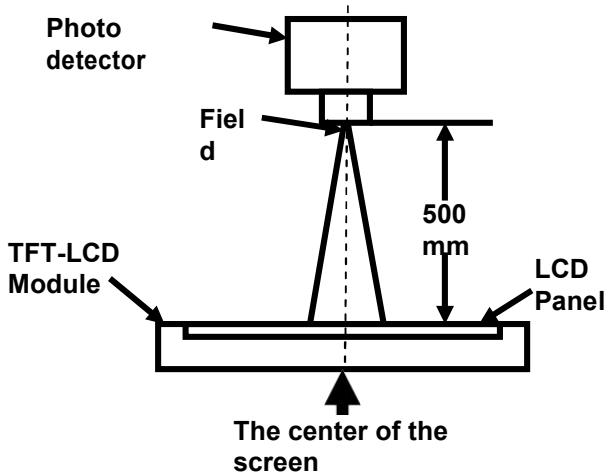

Item	Photo detector	Field
Contrast Ratio	SR-3A	1°
Luminance		
Chromaticity		
Lum Uniformity	BM-7A	2°
Response Time		

Note 2: Definition of viewing angle range and measurement system.

viewing angle is measured at the center point of the LCD by CONOSCOPE(ergo-80).

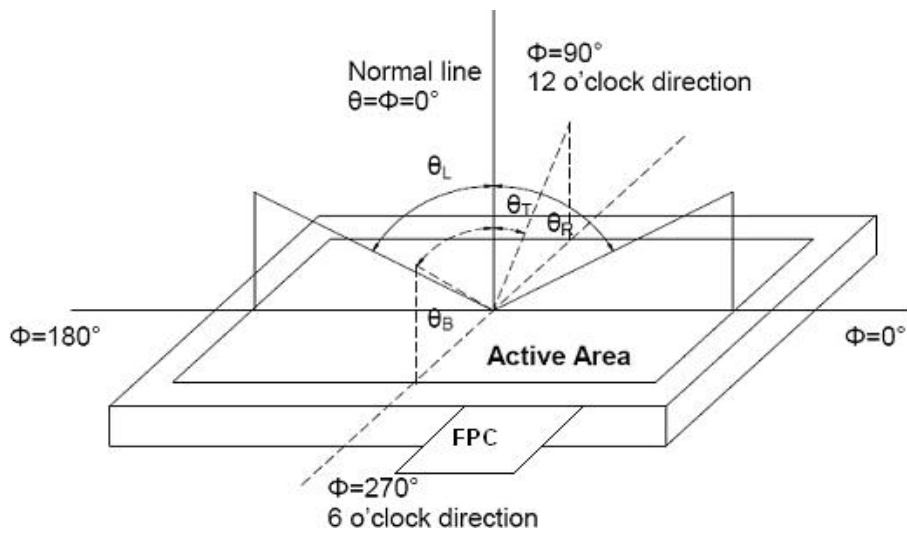

Fig. 1 Definition of viewing angle

Note 3: Definition of contrast ratio

$$\text{Contrast ratio (CR)} = \frac{\text{Luminance measured when LCD is on the "White" state}}{\text{Luminance measured when LCD is on the "Black" state}}$$

“White state “:The state is that the LCD should be driven by Vwhite.

“Black state”: The state is that the LCD should be driven by Vblack.

Vwhite: To be determined Vblack: To be determined.

Note 4: Definition of Response time

The response time is defined as the LCD optical switching time interval between “White” state and “Black” state. Rise time (TON) is the time between photo detector output intensity changed from 90% to 10%. And fall time (TOFF) is the time between photo detector output intensity changed from 10% to 90%.

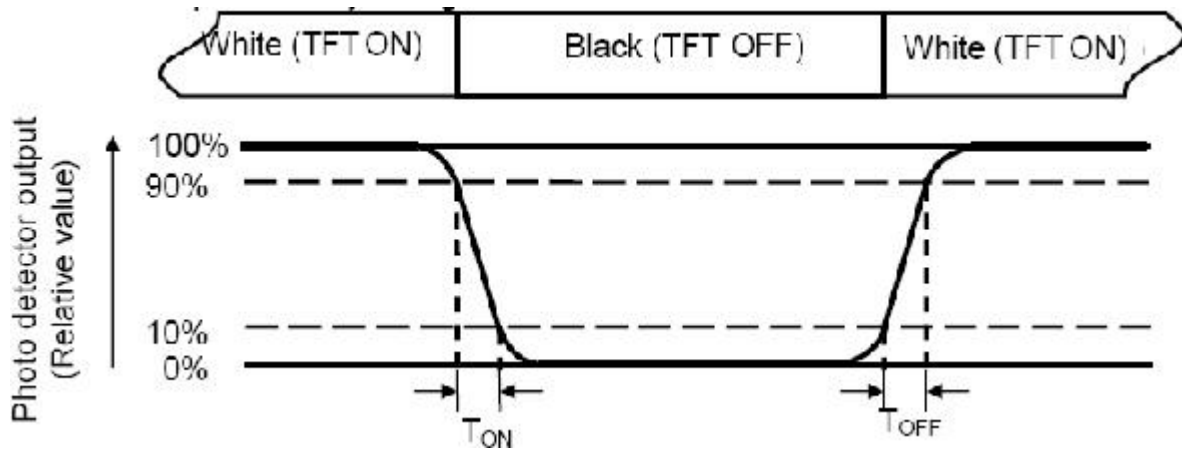

Note 5: Definition of color chromaticity (CIE1931)

Color coordinates measured at center point of LCD.

Note 6: Definition of Luminance Uniformity

Active area is divided into 9 measuring areas (Refer Fig. 2). Every measuring point is placed at the center of each measuring area.

Luminance Uniformity (U) = L_{min} / L_{max}

L-----Active area length W----- Active area width

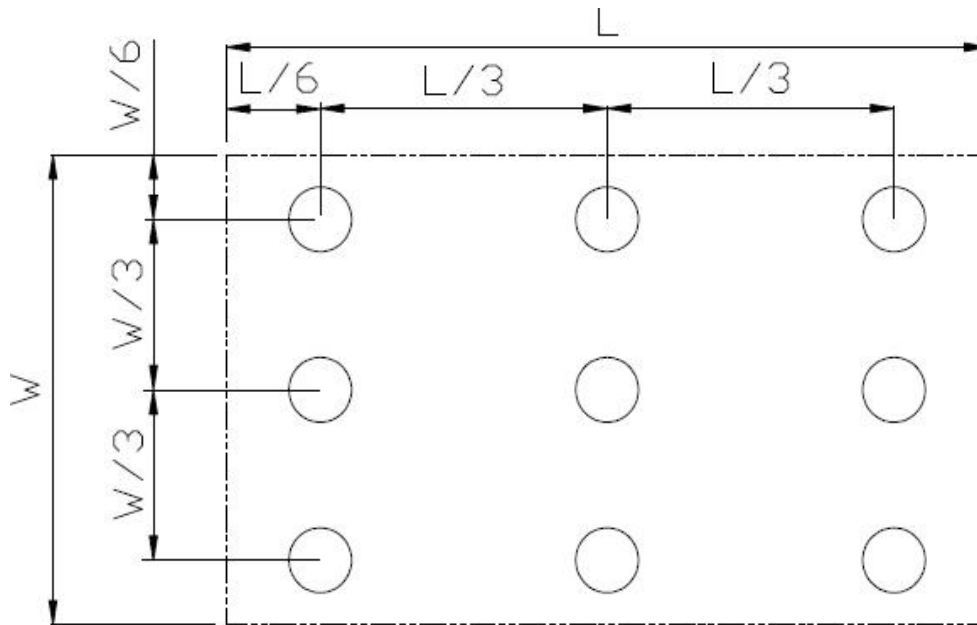

Fig. 2 Definition of uniformity

L_{max} : The measured maximum luminance of all measurement position.

L_{min} : The measured minimum luminance of all measurement position.

Note 7: Definition of Luminance:

Measure the luminance of white state at center point.

7 Environmental / Reliability Test

Item	Condition	Time (hrs)	Assessment
High temp. Storage	80°C	120	No abnormalities in functions and appearance
High temp. Operating	70°C	120	
Low temp. Storage	-30°C	120	
Low temp. Operating	-20°C	120	
Humidity	40°C/ 90%RH	120	
Thermal Shock(Non-operation)	-20°C → 25°C →70°C (0.5 hour → 5 min → 0.5 hour)	10cycles	

8 Mechanical Drawing

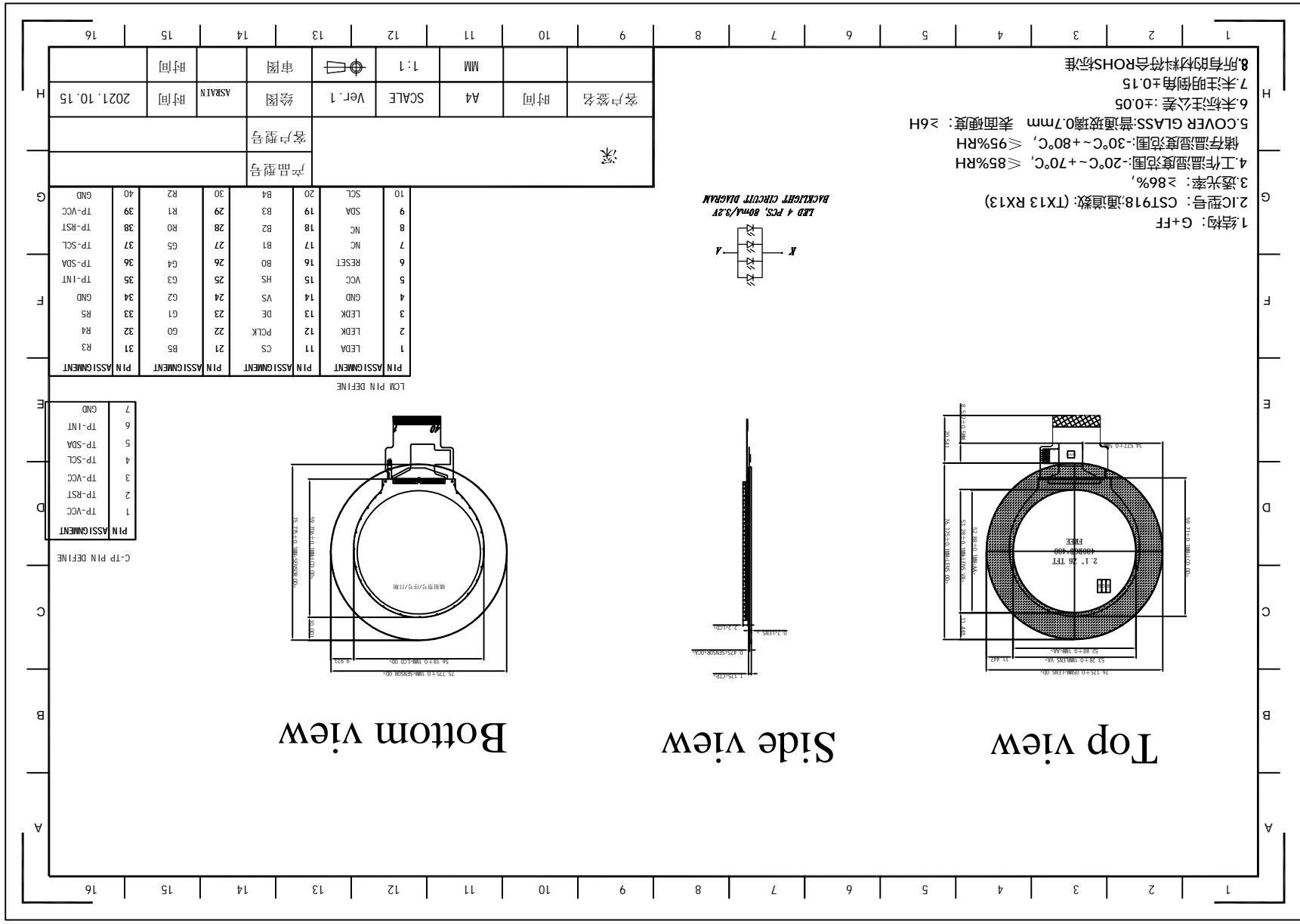

15 / 16 Jun. 18, 2019 Rev. 1.0

9 Precautions For Use of LCD Modules

9.1 Handling Precautions

- 9.1.1.1 The display panel is made of glass. Do not subject it to a mechanical shock by dropping it from a high place, etc.
- 9.1.1.2 If the display panel is damaged and the liquid crystal substance inside it leaks out, be sure not to get any in your mouth, if the substance comes into contact with your skin or clothes, promptly wash it off using soap and water.
- 9.1.1.3 Do not apply excessive force to the display surface or the adjoining areas since this may cause the color tone to vary.
- 9.1.1.4 The polarizer covering the display surface of the LCD module is soft and easily scratched. Handle this polarizer carefully.
- 9.1.1.5 If the display surface is contaminated, breathe on the surface and gently wipe it with a soft dry cloth. If still not completely clear, moisten cloth with one of the following solvents:
 - Isopropyl alcohol
 - Ethyl alcoholSolvents other than those mentioned above may damage the polarizer. Especially, do not use the following:
 - Water
 - Ketone
 - Aromatic solvents
- 9.1.1.6 Do not attempt to disassemble the LCD Module.
- 9.1.1.7 If the logic circuit power is off, do not apply the input signals.
- 9.1.1.8 To prevent destruction of the elements by static electricity, be careful to maintain an optimum work environment.
- 9.1.1.9 Be sure to ground the body when handling the LCD Modules.
- 9.1.1.10 Tools required for assembly, such as soldering irons, must be properly ground.
- 9.1.1.11 To reduce the amount of static electricity generated, do not conduct assembly and other work under dry conditions.
- 9.1.1.12 The LCD Module is coated with a film to protect the display surface. Be care when peeling off this protective film since static electricity may be generated.
- 9.1.1.13 Storage precautions
- 9.1.1.14 When storing the LCD modules, avoid exposure to direct sunlight or to the light of fluorescent lamps.
- 9.1.1.15 The LCD modules should be stored under the storage temperature range. If the LCD modules will be stored for a long time, the recommend condition is:
- 9.1.1.16 The LCD modules should be stored in the room without acid, alkali and harmful gas.

9.2 Transportation Precautions

The LCD modules should be no falling and violent shocking during transportation, and also should avoid excessive press, water, damp and sunshine.